



**REGISTRATION NUMBER :**  
**EXAM DATE : 31-August-2016**  
**EXAM NAME : SSC Examination 2016**  
**TOTAL MARKS : 200**

**CANDIDATE NAME :**  
**EXAM START TIME : 16:15:00**  
**EXAM DURATION : 01:15 Hrs**  
**TOTAL NO OF QUESTIONS : 100**

Question 1. Select the related word/letters/number from the given alternatives.

दिये गये विकल्पों में से संबंधित शब्द/अक्षरों/संख्या को चुनिए।

Coins : Mint :: Bricks : ?

मुद्रा : टकसाल :: ईंट : ?

**Options:**

- 1) Kiln  
भट्टी
- 2) Foundry  
ढलाई घर
- 3) Cementary  
सिमेंट्री
- 4) Finance  
पूँजी

**Correct Answer:** Kiln

भट्टी

**Candidate Answer:** Kiln

भट्टी

Question 2. Select the related word/letters/number from the given alternatives.

दिये गये विकल्पों में से संबंधित शब्द/अक्षरों/संख्या को चुनिए।

MOLTU : ? :: HOPE : IPQF

**Options:**

- 1) MPNUV
- 2) NPMUV
- 3) NPMVU
- 4) MPNVU

**Correct Answer:** NPMUV

**Candidate Answer:** NPMUV

Question 3. Select the related word/letters/number from the given alternatives.

दिये गये विकल्पों में से संबंधित शब्द/अक्षरों/संख्या को चुनिए।

456 : 15 :: 789 : ?

**Options:**

- 1) 22
- 2) 24
- 3) 26
- 4) 28

**Correct Answer:** 24

**Candidate Answer:** 24

Question 4.

**For the following questions**

**For the following questions**

Find the odd word/letters/number pair from the given alternatives.

दिए गए विकल्पों में से विषम शब्द/ संख्या/अक्षर/युग्म चुनिए।

**Options:**

1) TOP

2) COP

3) MOP

4) JOP

**Correct Answer:** JOP

**Candidate Answer:** MOP

Question 5.

**For the following questions**

Find the odd word/letters/number pair from the given alternatives.

दिए गए विकल्पों में से विषम शब्द/ संख्या/अक्षर/युग्म चुनिए।

**Options:**

1) BDF

2) NQS

3) TVX

4) HJL

**Correct Answer:** NQS

**Candidate Answer:** NQS

Question 6.

**For the following questions**

Find the odd word/letters/number pair from the given alternatives.

दिए गए विकल्पों में से विषम शब्द/ संख्या/अक्षर/युग्म चुनिए।

**Options:**

1) (3 , 12)

2) (2 , 6)

3) (6 , 42)

4) (5 , 35)

**Correct Answer:** (5 , 35)

**Candidate Answer:** (5 , 35)

Question 7. Arrange the following words as per order in the dictionary

निम्नलिखित शब्दों को शब्दकोश में दिए गए क्रम के अनुसार लिखिए।

1. Assassination 2. Association 3. Assimilate 4. Assimuthal

**Options:**

1) 1,2,3,4

2) 1,3,2,4

3) 1,3,4,2

4) 2,3,1,4

**Correct Answer:** 1,3,4,2

**Candidate Answer:** 1,3,4,2

Question 8. Choose the correct alternative from the given ones that will complete the below series

दिए गए विकल्पों में से सही विकल्प चुनिए जो अनुक्रम को पूरा करें

$\frac{W}{S} \frac{U}{O} \frac{S}{K} \frac{Q}{G}$

**Options:**

1) P/R

2) C/O

3) R/J

4) O/C

**Correct Answer:** O/C

**Candidate Answer:** O/C

Question 9. Find the wrong number in the series.

दी गई श्रृंखला में से गलत संख्या जात कीजिये।

225, 206, 188, 176, 165, 158, 153

**Options:**

1) 225

2) 188

3) 176

4) 153

**Correct Answer:** 188

**Candidate Answer:** 188

Question 10. The sum of the ages of father and a son presently is 70 years. After 10 years, the son's age is exactly half that of the father. What are their ages now?

एक पिता और उसके पुत्र की आयु का योग 70 साल है। 10 साल बाद पुत्र की उम्र पिता की उम्र से आधी होगी। अब उनकी उम्र कितनी हैं ?

**Options:**

1) 45 years, 25 years

45 वर्ष, 25 वर्ष

2) 50 years, 20 years

50 वर्ष, 20 वर्ष

3) 47 years, 23 years

47 वर्ष, 23 वर्ष

4) 50 years, 25 years

50 वर्ष, 25 वर्ष

**Correct Answer:** 50 years, 20 years

50 वर्ष, 20 वर्ष

**Candidate Answer:** 50 years, 20 years

50 वर्ष, 20 वर्ष

Question 11. If the third day of a month is Tuesday, which of the following would be the 25th day of that month?

यदि किसी महीने का तीसरा दिन मंगलवार हो तो उस महीने का 25वाँ दिन कौन-सा होगा ?

**Options:**

1) Tuesday

मंगलवार

2) Monday

सोमवार

3) Wednesday

बुधवार

4) Sunday

रविवार

**Correct Answer:** Monday

सोमवार

**Candidate Answer:** Wednesday

बुधवार

Question 12. From the given words, select the word which cannot be formed using the letters of the given word.

निम्नलिखित विकल्पों में से वह शब्द चुनिए जो दिए गए शब्द के अक्षरों का प्रयोग करके नहीं बनाया जा सकता है।

CIRCUMSTANCES

**Options:**

1) DISTANCE

2) STANCE

3) MUSIC

4) CIRCUS

**Correct Answer:** DISTANCE

**Candidate Answer:** DISTANCE

Question 13.If BUDDHISM is coded as DWFFJKUO then CHRISTIAN will be coded as \_\_\_\_\_ .

यदि एक कोड में 'BUDDHISM' को 'DWFFJKUO' लिखा जाता है, तो उस कोड में 'CHRISTIAN' को क्या लिखा जायेगा ?

**Options:**

1) EITJUVKBP

2) EJTKUVJCO

3) EJTKVUJCP

4) EJTKUVKCP

**Correct Answer:** EJTKUVKCP

**Candidate Answer:** EJTKUVKCP

Question 14.Some equations are solved on the basis of certain system. Find out the correct answer for unsolved equation on that basis:

कुछ समीकरणों को एक निश्चित प्रणाली के आधार पर हल किया जाता है। उसी आधार पर इस समीकरण का सही उत्तर बताइए।  
 $4 \times 5 \times 8 = 584$ ,  $7 \times 3 \times 9 = 397$ ,  $9 \times 7 \times 3 = ?$

**Options:**

1) 397

2) 793

3) 973

4) 739

**Correct Answer:** 739

**Candidate Answer:** 739

Question 15.If - means  $\div$ , + means  $\times$ ,  $\div$  means  $-$ ,  $\times$  means  $+$ , then which of the following equations is correct?

यदि - का मतलब है  $\div$ , + का मतलब है  $\times$ ,  $\div$  का मतलब है  $-$ ,  $\times$  का मतलब है  $+$ , तो निम्नलिखित में से कौन-सा समीकरण सही है ?

**Options:**

1)  $43 \times 7 \div 5 + 4 - 8 = 25$

2)  $48 \div 5 + 8 \times 10 - 2 = 03$

3)  $36 \times 4 - 12 + 5 \div 3 = 420$

4)  $42 + 5 \div 6 \times 8 - 3 = 28$

**Correct Answer:**  $48 \div 5 + 8 \times 10 - 2 = 03$

**Candidate Answer:**  $48 \div 5 + 8 \times 10 - 2 = 03$

Question 16.Find the missing number from the given response.

दिए गए विकल्पों में से लुप्त संख्या ज्ञात कीजिए ?

7	3	2
4	9	6
2	1	5
69	91	?

**Options:**

1) 58

2) 65

3) 64

4) 51

**Correct Answer:** 65

**Candidate Answer:** 65

Question 17. Facing the East, Rahul turned left and walked 10m, then he turned to his left again and walked 10m. He then turned towards his right and went straight to cover 25m. In which direction is he from his starting point?

पूर्व की ओर देखते हुए राहुल बायीं ओर मुड़ा और 10 मी. चला, फिर वह बायीं ओर मुड़ा और 10 मी. चला। फिर वह अपने दायीं ओर मुड़ा और सीधे 25 मी. चला। अब वह प्रारम्भिक बिन्दु से किस दिशा में है ?

**Options:**

1) North-West

उत्तर- पश्चिम

2) North-East

उत्तर- पूर्व

3) South-West

दक्षिण- पश्चिम

4) South-East

दक्षिण- पूर्व

**Correct Answer:** North-West

उत्तर- पश्चिम

**Candidate Answer:** North-East

उत्तर- पूर्व

Question 18. Consider the given statement/s to be true and decide which of the given conclusions/assumptions can definitely be drawn from the given statement.

Statement: Laugh and the world will laugh with you.

Assumptions:

I. People generally laugh.

II. Laughter symbolises happiness.

निम्नलिखित प्रश्न में एक या दो वक्तव्य दिये गये हैं, जिसके आगे दो निष्कर्ष/मान्यताएं, I और II निकाले गये हैं। आपको विचार करना है कि वक्तव्य सत्य है चाहे वह सामान्यतः शर्त तथ्यों से भिन्न प्रतीत होता हो। आपको निर्णय करना है कि दिए गए वक्तव्य में से कोन-सा निश्चित रूप से सही निष्कर्ष/मान्यता निकाला जा सकता है ?

वक्तव्य : हँसो और दुनिया तुम्हारे साथ हँसेगी।

मान्यता 1. लोग आम तौर पर हँसते हैं।

मान्यता 2. हँसी खुशी का प्रतीक है।

**Options:**

1) Only I is an assumption

केवल निष्कर्ष I सही है।

2) Only II is an assumption

केवल निष्कर्ष II सही है।

3) Both I and II are assumptions

दोनों निष्कर्ष I और II सही हैं।

4) Neither I nor II is an assumption

ना तो निष्कर्ष I और ना ही निष्कर्ष II सही है।

**Correct Answer:** Neither I nor II is an assumption

ना तो निष्कर्ष I और ना ही निष्कर्ष II सही हैं।

**Candidate Answer:** Only II is an assumption

केवल निष्कर्ष II सही है।

Question 19. How many triangles are there in the given figure?

दी गई आकृति में कितने त्रिकोण हैं ?

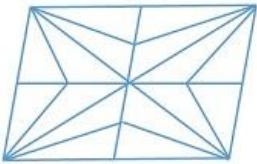

**Options:**

1) 24

2) 28

3) 36

4) 32

**Correct Answer:** 36

**Candidate Answer:** 36

Question 20. Identify the diagram that best represents the relationship among classes given below:

ELEPHANTS, WOLVES, ANIMALS

वह आरेख चुनिए जो नीचे दिए गए वर्गों के बीच सम्बंध का सही निरूपण करता है।

हाथी, भेड़िये, जानवर

**Options:**

1)



2)

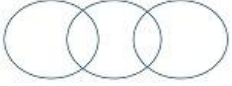

3)

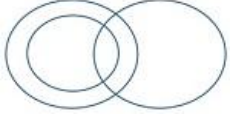

4)



**Correct Answer:**



**Candidate Answer:**



Question 21. Which answer figure will complete the pattern in the question figure?

कौन-सी उत्तर आकृति प्रश्न आकृति के प्रतिरूप को पूरा करेगी ?

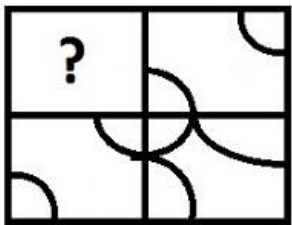

**Options:**

1)



2)





3)



4)



**Correct Answer:**

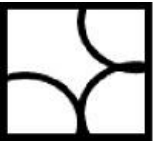

**Candidate Answer:**



Question 22. From the given answer figures, select the one in which the question figure is hidden/embedded

दी गई उत्तर आकृतियों में से उस आकृति को चुनिए जिसमें प्रश्न आकृति निहित है।

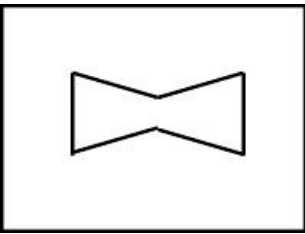

**Options:**

1)

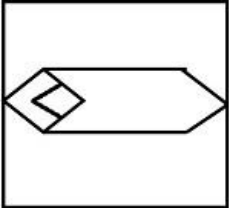

2)

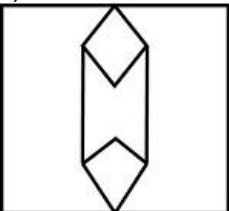

3)



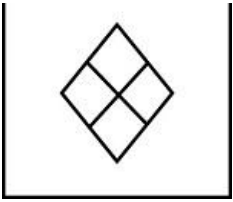

4)

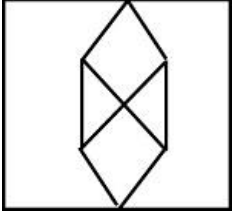

**Correct Answer:**

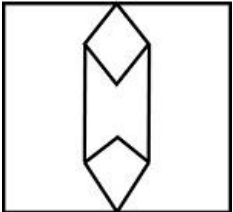

**Candidate Answer:**

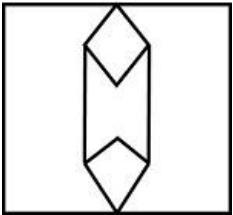

Question 23. A piece of paper is folded and cut as shown below in the question figures. From the given answer figures, indicate how it will appear when opened.

निम्नलिखित उत्तर आकृतियों में से यह ज्ञात कीजिए कि नीचे दिखाए अनुसार कागज को मोड़ने, काटने तथा खोलने के बाद वह किस आकृति जैसे दिखाई देगा ?

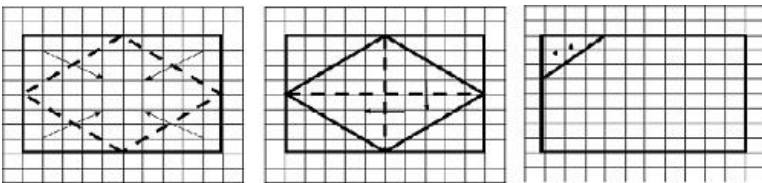

**Options:**

1)

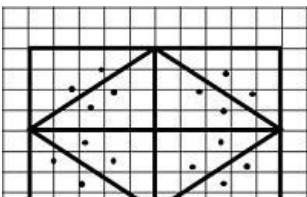



2)

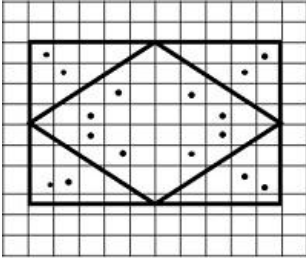

3)

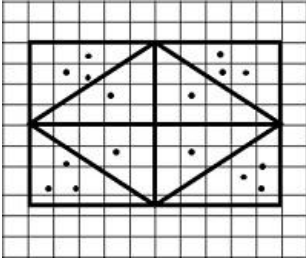

4)

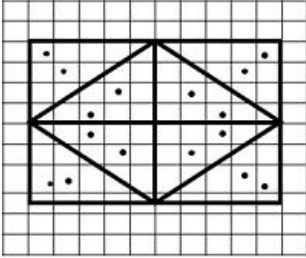

Correct Answer:

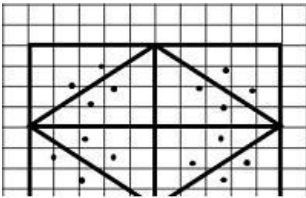

Candidate Answer: [ NOT ANSWERED ]

Question 24.If a mirror is placed on the line MN, then which of the answer figures is the right image of the given figure?

यदि एक दर्पण को MN रेखा पर रखा जाए तो दी गई उत्तर आकृतियों में से कौन-सी आकृति प्रश्न आकृति का सही प्रतिबिम्ब होगी ?

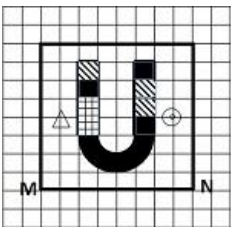

Options:

1)

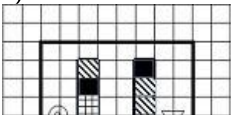

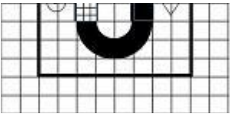

2)

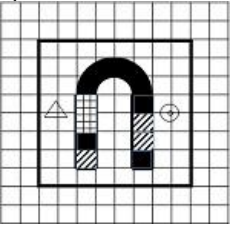

3)

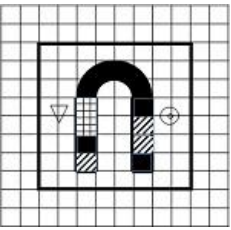

4)

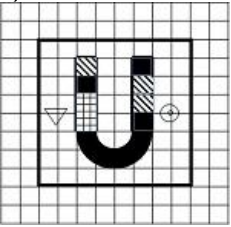

**Correct Answer:**

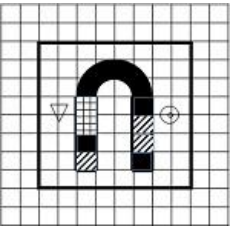

**Candidate Answer:**

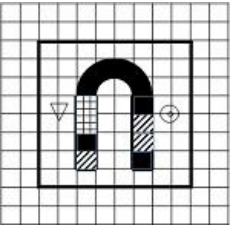

Question 25. In this question, the sets of numbers given in the alternatives are represented by two classes of alphabets as in two matrices given below. The columns and rows of Matrix I are numbered from 0 to 4 and that of Matrix II are numbered from 5 to 9. A letter from these matrices can be represented first by its row and next by its column, e.g., 'D' can be represented by 01, 13, etc., and 'N' can be represented by 59, 66, etc.

You have to identify the set for the word 'HEEL'

एक शब्द केवल एक संख्या-समूह द्वारा दर्शाया गया है, जैसा कि विकल्पों में से किसी एक में दिया गया है। विकल्पों में दिए गए संख्या समूह अक्षरों के दो वर्गों द्वारा दर्शाए गए हैं, जैसे कि नीचे दिए गए दो आव्यूहों में हैं। आव्यूह I के स्तंभ और पंक्तियों की संख्या 0 से 4 और आव्यूह II की 5 से 9 दी गई है। इन आव्यूहों से एक अक्षर को पहले उसकी पंक्ति और बाद में स्तंभ संख्या द्वारा दर्शाया जा सकता है। उदाहरण के लिए 'D' को 01, 13 आदि द्वारा दर्शाया जा सकता है तथा 'N' को 59, 66 आदि द्वारा दर्शाया जा सकता है। इसी तरह से आपको दिए हुए शब्द 'HEEL' के लिए समूह को पहचानना है।

MATRIX I					
	0	1	2	3	4
0	C	D	E	F	G
1	F	G	C	D	E
2	D	E	F	G	C
3	E	F	G	C	D
4	G	C	D	E	F

MATRIX II					
	5	6	7	8	9
5	H	K	L	I	N
6	I	N	H	K	L
7	K	L	I	N	H
8	L	I	N	H	K
9	N	H	K	L	I

**Options:**

1) 67, 21, 14, 98

2) 75, 88, 65, 01

3) 68, 65, 60, 10

4) 68, 65, 50, 01

**Correct Answer:** 67, 21, 14, 98

**Candidate Answer:** 67, 21, 14, 98

Question 26. The term 'Macro Economics' was used by \_\_\_\_\_ .

" वृहत अर्थशास्त्र " (Macro Economics) शब्द का प्रयोग किसने किया था ?

**Options:**

1) J.M. Keynes

जे.एम. केन्स

2) Ragner Frisch

रागनेर फ्रिस्क

3) Ragner Nurkse

रागनेर न्युक्स

4) Prof. Knight

प्रो. नाइट

**Correct Answer:** Ragner Frisch

रागनेर फ्रिस्क

**Candidate Answer:** J.M. Keynes

जे.एम. केन्स

Question 27. Who was the first Chancellor of Jamia Millia Islamia University at Aligarh?

अलीगढ़ में स्थित जामिया मिलिया इस्लामिया विश्वविद्यालय के प्रथम कुलपति कौन थे ?

**Options:**

1) Abdul Ghaffar Khan

अब्दुल गफ्फार खान

2) Rajkumari Amrit Kaur

राजकुमारी अमृत कौर

3) Hakim Ajmal Khan

हाकिम अजमल खान

4) Sir Sayyad Ahmad Khan

सर सैयद अहमद खान

**Correct Answer:** Hakim Ajmal Khan

हाकिम अजमल खान

**Candidate Answer:** Abdul Ghaffar Khan

अब्दुल गफ्फार खान

Question 28. Who were the patrons of Sangama Literature?

संगम साहित्य के संरक्षक कौन थे ?

**Options:**

1) Nayakas

नायक

2) Chandellas

चंदेल

3) Pandyas

पांड्य

4) Solankis

सोलंकी

**Correct Answer:** Pandyas

पांड्य

**Candidate Answer:** Chandellas  
चंदेल

Question 29. Where in India was the first French factory established?

भारत में पहली फ्रेंच फैक्टरी कहाँ स्थापित की गई थी ?

**Options:**

1) Surat

सूरत

2) Pondicherry

पांडीचेरी

3) Chandannagore

चंदन नागोर

4) Masulipatnam

मछलीपटनम

**Correct Answer:** Surat

सूरत

**Candidate Answer:** Masulipatnam

मछलीपटनम

Question 30. Which algorithm is used to decide the path to transfer the packets from source to destination?

स्रोत स्थल से गंतव्य तक पैकेटों को स्थानांतरित करने के मार्ग का निर्णय करने के लिए किस कलनविधि का प्रयोग किया जाता है ?

**Options:**

1) Routing

मार्ग निर्देश

2) Pathing

पथ निर्धारण

3) Selecting

चयन

4) Directing

निर्देशन

**Correct Answer:** Routing

मार्ग निर्देश

**Candidate Answer:** [ NOT ANSWERED ]

Question 31. Which one of the following is an ohmic conductor?

निम्नलिखित में से ओम-चालक कौन-सा है ?

**Options:**

1) Germanium

जर्मेनियम

2) Silicon

सिलिकॉन

3) Carbon

कार्बन

4) Silver

सिल्वर

**Correct Answer:** Silver

सिल्वर

**Candidate Answer:** Silver

सिल्वर

Question 32. Which mechanism is used by the computer virus 'worm' to duplicate itself?

कंप्यूटर वायरस 'worm' द्वारा स्वयं की पुनरावृत्ति के लिए किस युक्ति का प्रयोग किया जाता है ?

**Options:**

1) Swap

स्वैप

2) Increment

इन्क्रीमेंट

3) Spawn

स्पॉन

4) Swarm

स्वार्म

**Correct Answer:** Spawn

स्पॉन

**Candidate Answer:** Increment

इन्क्रीमेंट

Question 33. The first Commonwealth Games in 1930 was held in which country?

1930 में प्रथम राष्ट्रमंडल खेलों का आयोजन किस देश में किया गया था ?

**Options:**

- 1) Australia  
ऑस्ट्रेलिया
- 2) England  
इंग्लैंड
- 3) New Zealand  
न्यूजीलैंड
- 4) Canada  
कनाडा

**Correct Answer:** Canada

कनाडा

**Candidate Answer:** Canada

कनाडा

Question 34. The gentle 'seaward sloping' surface from the coasts is called \_\_\_\_\_.

तटों से, हल्की "समुद्र अभिमुखी ढलान" को क्या कहते हैं ?

**Options:**

- 1) Continental shelf  
महाद्वीपीय कगार
- 2) Continental rise  
महाद्वीपीय पहाड़ी
- 3) Abyssal plains  
पितलीय मैदान
- 4) Submarine ridges  
अंतःसमुद्री पर्वत श्रेणी

**Correct Answer:** Continental shelf

महाद्वीपीय कगार

**Candidate Answer:** [ NOT ANSWERED ]

Question 35. The aim of Differentiated Interest Scheme was to provide concessional loans to \_\_\_\_\_.

भिन्नात्मक ब्याज प्रणाली का उद्देश्य, निम्न में से किन्हें रियासती कर्ज प्रदान करना है?

**Options:**

- 1) weaker section of the society  
समाज के कमजोर वर्ग को
- 2) Public Sector Industries  
सार्वजनिक क्षेत्र के उद्योगों को
- 3) Public Limited Companies  
पब्लिक लिमिटेड कंपनियों को
- 4) big exports  
बड़े निर्यात

**Correct Answer:** weaker section of the society

समाज के कमजोर वर्ग को

**Candidate Answer:** [ NOT ANSWERED ]

Question 36. Anemometer is an instrument meant for measuring \_\_\_\_\_.

एनिमोमीटर से, दिए गए विकल्पों में से, क्या मापा जाता है ?

**Options:**

- 1) velocity  
वेग
- 2) air masses  
हवा का द्रव्यमान
- 3) wind speed  
हवा की गति
- 4) temperature  
तापमान

**Correct Answer:** wind speed

हवा की गति

**Candidate Answer:** wind speed

हवा की गति

Question 37. Tax on inheritance is called \_\_\_\_\_.

पैतृक सम्पत्ति पर जो कर लगता है उसे क्या कहते हैं ?

**Options:**

- 1) Excise duty  
उत्पाद कर
- 2) Estate duty  
जायदाद कर
- 3) Gift tax  
उपहार कर
- 4) Sales tax

बिक्री कर

**Correct Answer:** Estate duty

जायदाद कर

**Candidate Answer:** Estate duty

जायदाद कर

Question 38. The silver coin 'tanka' was introduced by \_\_\_\_\_ .

चांदी का सिक्का 'टंका' किसने चलाया था ?

**Options:**

1) Qutubuddin Aibak

कुतुबुद्दीन ऐबक

2) Iltutmish

इल्तुतमिश

3) Balban

बलबन

4) Bahram Khan

बहराम खान

**Correct Answer:** Iltutmish

इल्तुतमिश

**Candidate Answer:** Iltutmish

इल्तुतमिश

Question 39. Which of the following international prizes/awards is given for outstanding contribution in the field of Journalism?

निम्नलिखित में से कौन सा अंतर्राष्ट्रीय पुरस्कार पत्रकारिता के क्षेत्र में सर्वोत्तम योगदान के लिए दिया जाता है ?

**Options:**

1) Oscar Award

ऑस्कर पुरस्कार

2) Booker Prize

बुकर पुरस्कार

3) Pulitzer Prize

पुलित्जर पुरस्कार

4) Sullivan Award

सुल्लिवन पुरस्कार

**Correct Answer:** Pulitzer Prize

पुलित्जर पुरस्कार

**Candidate Answer:** Pulitzer Prize

पुलित्जर पुरस्कार

Question 40. The country which tops in the production of cocoa is \_\_\_\_\_ .

कोकोआ के उत्पादन में कौन-सा देश सबसे आगे है ?

**Options:**

1) Ghana

घाना

2) Brazil

ब्राज़ील

3) Ivory Coast

आइवरी कोस्ट

4) Nigeria

नाइजीरिया

**Correct Answer:** Ghana

घाना

**Candidate Answer:** Brazil

ब्राज़ील

Question 41. Increased RBC's in the blood leads to a condition called \_\_\_\_\_ .

रक्त में RBC के बढ़ने से कौन-सी स्थिति बन जाती है ?

**Options:**

1) Anemia

एनीमिया

2) Haemophilia

हेमोफीलिया

3) Polycythemia

पॉलीसाइथेमिया

4) Leukaemia

लूकेमिया

**Correct Answer:** Polycythemia

पॉलीसाइथेमिया

**Candidate Answer:** Polycythemia

पॉलीसाइथेमिया

Question 42. The spring balance works on the principle of \_\_\_\_\_ .

कमानी तुला किस सिद्धांत पर काम करती है ?

**Options:**

- 1) Boyle's Law  
बॉयल नियम
- 2) Hooke's Law  
हुक नियम
- 3) Bernoulli's principle  
बर्नोली सिद्धांत
- 4) Pascal's Law  
पास्कल नियम

**Correct Answer:** Hooke's Law

हुक नियम

**Candidate Answer:** Pascal's Law

पास्कल नियम

Question 43. If there were no gravity, which of the following will not be there for a fluid?

अगर आकर्षण शक्ति ना हो, तो निम्नलिखित में से कौन-सा तरल पदार्थ के लिए लागू नहीं होगा ?

**Options:**

- 1) Viscosity  
चिपचिपापन
- 2) Surface Tension  
पृष्ठ तनाव
- 3) Pressure  
दबाव
- 4) Upward Thrust  
ऊपरी दबाव

**Correct Answer:** Upward Thrust

ऊपरी दबाव

**Candidate Answer:** Pressure

दबाव

Question 44. Calcium salts used as fertilizer is:

उर्वरकों के रूप में कौन से कैल्शियम लवण प्रयुक्त होते हैं ?

**Options:**

- 1) Calcium Carbide  
कैल्शियम कार्बाइड
- 2) Calcium Carbonate  
कैल्शियम कार्बोनेट
- 3) Calcium Cyanide  
कैल्शियम साइनाइड
- 4) Calcium Sulphate  
कैल्शियम सल्फेट

**Correct Answer:** Calcium Sulphate

कैल्शियम सल्फेट

**Candidate Answer:** Calcium Carbide

कैल्शियम कार्बाइड

Question 45. The Jawaharlal Nehru Award is given for \_\_\_\_\_ .

जवाहरलाल नेहरू पुरस्कार किसलिए दिया जाता है ?

**Options:**

- 1) Government service  
सरकारी सेवा
- 2) Literary work  
साहित्यिक सेवा
- 3) International understanding  
अन्तर्राष्ट्रीय समझदारी
- 4) Social work  
सामाजिक कार्य

**Correct Answer:** International understanding

अन्तर्राष्ट्रीय समझदारी

**Candidate Answer:** International understanding

अन्तर्राष्ट्रीय समझदारी

Question 46. Which of the following is called 'Queen of the Adriatic'?

निम्नलिखित में से 'एड्रिएटिक की रानी' किसे कहते हैं ?

**Options:**

- 1) Venice

1) Venice

वेनिस

2) Rome

रोम

3) Flanders

फ्लैंडर्स

4) Lisbon

लिस्बन

**Correct Answer:** Venice

वेनिस

**Candidate Answer:** [ NOT ANSWERED ]

Question 47. The liberation of oxygen during photosynthesis is due to \_\_\_\_\_ .

प्रकाश संश्लेषण के दौरान ऑक्सीजन किस कारण विमोचित होती है ?

**Options:**

1) hydrolysis of carbohydrates

कार्बोहाइड्रेट का जल अपघटन

2) photolysis of water

जल का प्रकाश अपघटन

3) reduction of CO<sub>2</sub>

CO<sub>2</sub> की कमी

4) breakdown of chlorophyll

क्लोरोफिल का टूट जाना

**Correct Answer:** photolysis of water

जल का प्रकाश अपघटन

**Candidate Answer:** photolysis of water

जल का प्रकाश अपघटन

Question 48. Formic acid is produced by \_\_\_\_\_ .

फॉर्मिक एसिड किसके द्वारा उत्पन्न होता है ?

**Options:**

1) White ants

दौमक

2) Cockroaches

कॉकरोच (तिलचट्टा)

3) Red ants

लाल चींटी

4) Mosquitoes

मच्छर

**Correct Answer:** Red ants

लाल चींटी

**Candidate Answer:** Red ants

लाल चींटी

Question 49. Which one of the following forms of phosphorus is most reactive?

निम्नलिखित में से फॉस्फोरस का कौन-सा रूप सबसे ज्यादा प्रतिक्रियाशील है ?

**Options:**

1) Black phosphorus

काला फॉस्फोरस

2) White phosphorus

श्वेत फॉस्फोरस

3) Violet phosphorus

बैंगनी फॉस्फोरस

4) Red phosphorus

लाल फॉस्फोरस

**Correct Answer:** White phosphorus

श्वेत फॉस्फोरस

**Candidate Answer:** White phosphorus

श्वेत फॉस्फोरस

Question 50. Zubin Mehta is associated with \_\_\_\_\_ .

जुबीन मेहता किस क्षेत्र से सम्बन्धित है ?

**Options:**

1) Literature

साहित्य

2) Painting

चित्रकारी

3) Music

संगीत



4) Journalism

पत्रकारी

**Correct Answer:** Music

संगीत

**Candidate Answer:** Painting

चित्रकारी

Question 51.If  $3^{10} \times 27^2 = 9^2 \times 3^n$  then the value of n is

यदि  $3^{10} \times 27^2 = 9^2 \times 3^n$  हो, तो n का मान बताइए ?

**Options:**

1) 10

2) 12

3) 15

4) 30

**Correct Answer:** 12

**Candidate Answer:** 10

Question 52.The radius of two cylinders are in the ratio of 3:2 and their heights are in the ratio 3:7. The ratio of their volumes is :

दो बेलनों की त्रिज्याओं के बीच 3:2 का अनुपात है और उनकी ऊंचाई में 3:7 का अनुपात है। उनके आयतनों का अनुपात बताइए ?

**Options:**

1) 4:7

2) 7:4

3) 28:27

4) 27:28

**Correct Answer:** 27:28

**Candidate Answer:** 27:28

Question 53.The list price (marked price ) of an article is Rs. 900 and is available at two successive discounts of 20% and 10% ; the selling price of the article, in rupees, is

किसी वस्तु का अंकित मूल्य 900 Rs. है और वह 20% और 10% के क्रमिक छूट पर उपलब्ध है। उस वस्तु का रुपयों में विक्रय मूल्य बताइए ?

**Options:**

1) 640

2) 648

3) 720

4) 738

**Correct Answer:** 648

**Candidate Answer:** 648

Question 54.A, B and C enter into a partnership, investing Rs. 6000. A invests Rs. 1000 and B and C invests in the ratio of 2:3. Find the profit of C, when the annual profit is Rs. 2400

A, B और C Rs. 6000 निवेश करके साझेदारी शुरू करते हैं। A उसमें Rs. 1000 का निवेश करता है तथा B और C 2:3 के अनुपात में निवेश करते हैं। यदि वार्षिक लाभ Rs. 2400 हो, तो बताइए कि C को कितना लाभ हुआ ?

**Options:**

1) Rs.600

2) Rs.1200

3) Rs.1800

4) Rs.1950

**Correct Answer:** Rs.1200

**Candidate Answer:** Rs.1200

Question 55.Average of two numbers is 8 and average of other three numbers is 3 ; the average of the five numbers is

दो संख्याओं का औसत 8 है और अन्य तीन संख्याओं का औसत 3 है। पांचों संख्याओं का औसत बताइए ?

**Options:**

1) 2

2) 3

3) 5

4) 6

**Correct Answer:** 5

**Candidate Answer:** 5

Question 56. To make a profit of 20% the selling price of the good is Rs. 240. The cost price of the good is,

यदि किसी वस्तु को Rs. 240 में बेचने पर 20% का लाभ होता है, तो उस वस्तु का क्रय मूल्य ज्ञात कीजिए ?

**Options:**

1) Rs. 200

2) Rs. 210

3) Rs. 220

4) Rs. 230

**Correct Answer:** Rs. 200

**Candidate Answer:** Rs. 200

Question 57. In an examination, 35% of total students failed in Hindi, 45% failed in English and 20% failed in both. Find the percentage of those students who passed in both the subjects ?

किसी परीक्षा में 35% छात्र हिन्दी में फेल हुए, 45% छात्र अंग्रेजी में फेल हुए और 20% छात्र दोनों विषयों में फेल हुए। उन छात्रों का प्रतिशत ज्ञात कीजिए जो दोनों विषयों में पास हुए ?

**Options:**

1) 45%

2) 35%

3) 20%

4) 40%

**Correct Answer:** 40%

**Candidate Answer:** 40%

Question 58. A man travels 50 km at speed 25 km/h and next 40 km at 20 km/h and there after travel 90km at 15 km/h. His average speed is

कोई व्यक्ति 50 कि.मी. की यात्रा 25 कि.मी. प्रति घण्टे की चाल से तय करता है और अगली 40 कि.मी. की यात्रा 20 कि.मी. प्रति घण्टे की चाल से तय करता है और उसके बाद 90 कि.मी. की यात्रा 15 कि.मी. प्रति घण्टे की चाल से तय करता है। उसकी औसत चाल क्या है ?

**Options:**

1) 18

2) 25

3) 20

4) 15

**Correct Answer:** 18

**Candidate Answer:** 18

Question 59.

If  $x + \frac{1}{x} \neq 0$  and  $x^3 + \frac{1}{x^3} = 0$  then the value  $(x + \frac{1}{x})^4$  is

यदि  $x + \frac{1}{x} \neq 0$  और  $x^3 + \frac{1}{x^3} = 0$  हो तो  $(x + \frac{1}{x})^4$  का मान बताइए।

**Options:**

1) 9

2) 12

3) 15

4) 16

**Correct Answer:** 9

**Candidate Answer:** [ NOT ANSWERED ]

Question 60.

If  $x + \frac{1}{x} = 2$  then  $x^2 + \frac{1}{x^2}$  is equal to

यदि  $x + \frac{1}{x} = 2$ , हो तो  $x^2 + \frac{1}{x^2}$  किसके बराबर होगा?

**Options:**

1) 0

2) 2

3) 4

4) 8

**Correct Answer:** 2

**Candidate Answer:** 2

Question 61. The orthocentre of a triangle lies on one of the sides. Then \_\_\_\_\_

यदि किसी त्रिकोण का लंब-केन्द्र किसी एक भुजा पर है, तो \_\_\_\_\_

**Options:**

1) The orthocentre lies on a vertex

लंब केन्द्र शिरोबिन्दु पर है

2) circumcentre lies outside the triangle

परिकेन्द्र त्रिकोण के बाहर है

3) circumcentre lies on the same side

परिकेन्द्र उसी भुजा पर है

4) centroid coincides with orthocentre

केन्द्रक लंब केन्द्र के साथ ही है

**Correct Answer:** The orthocentre lies on a vertex

लंब केन्द्र शिरोबिन्दु पर है

**Candidate Answer:** [ NOT ANSWERED ]

Question 62. Three sides of a triangle are 5 cm, 9 cm and x cm. The minimum integral value of x is

किसी त्रिकोण की तीन भुजाएं 5 से.मी., 9 से.मी. और x से.मी. हैं। x का न्यूनतम पूर्ण मान बताइए ?

**Options:**

1) 2

2) 3

3) 4

4) 5

**Correct Answer:** 5

**Candidate Answer:** 5

Question 63. The value of  $\cos^2 20^\circ + \cos^2 70^\circ$  is

$\cos^2 20^\circ + \cos^2 70^\circ$  का मान ज्ञात कीजिए ?

**Options:**

1)  $\sqrt{2}$

2) 2

3)  $\frac{1}{\sqrt{2}}$

4) 1

**Correct Answer:** 1

**Candidate Answer:** 1

Question 64. If 5 person together can make 5 mats in 5 hrs, then 10 person in 10 hours will make

यदि 5 व्यक्ति मिलकर 5 घण्टे में 5 चटाइयां बना सकते हैं। तो 10 व्यक्ति 10 घंटे में कितनी चटाइयां बनाएंगे ?

**Options:**

1) 20 mats

20 चटाइयां

2) 10 mats

10 चटाइयां

3) 15 mats

15 चटाइयां

4) 5 mats

5 चटाइयां

**Correct Answer:** 20 mats

20 चटाइयाँ

**Candidate Answer:** 20 mats

20 चटाइयाँ

Question 65.If  $a + b = 17$  and  $a - b = 9$  then the value of  $(4a^2 + 4b^2)$  is,

यदि  $a + b = 17$  और  $a - b = 9$  हो, तो  $(4a^2 + 4b^2)$  का मान बताइए ?

**Options:**

1) 710

2) 720

3) 730

4) 740

**Correct Answer:** 740

**Candidate Answer:** 740

Question 66.If  $x + y = \sqrt{3}$  and  $x - y = \sqrt{2}$ , then the value of  $8xy(x^2 + y^2)$  is

यदि  $x + y = \sqrt{3}$  और  $x - y = \sqrt{2}$  हो, तो  $8xy(x^2 + y^2)$  का मान बताइए ?

**Options:**

1) 6

2)  $\sqrt{6}$

3) 5

4)  $\sqrt{5}$

**Correct Answer:** 5

**Candidate Answer:** 5

Question 67.The length of a chord which is at a distance of 5cm from the centre of a circle of radius 13cm is

किसी ऐसी जीवा की लम्बाई क्या होगी जो 13 से.मी. त्रिज्या वाले वृत्त के केन्द्र से 5 से.मी. की दूरी पर हो ?

**Options:**

1) 18cm

18 से.मी.

2) 24cm

24 से.मी.

3) 25cm

25 से.मी.

4) 30cm

30 से.मी.

**Correct Answer:** 24cm

24 से.मी.

**Candidate Answer:** 24cm

24 से.मी.

Question 68.If the measures of the angles of a triangle are in the ratio. 1:2:3 and if the length of the smallest side of the triangle is 10cm, then the length of the longest side is

यदि किसी त्रिकोण के कोणों की माप 1:2:3 के अनुपात में हैं और त्रिकोण की सबसे छोटी भुजा की लम्बाई 10 से.मी. है, तो उसकी सबसे लम्बी भुजा की लम्बाई बताइए ?

**Options:**

1) 20cm

20 से.मी.

2) 25cm

25 से.मी.

3) 30cm

30 से.मी.

4) 35cm

35 से.मी.

**Correct Answer:** 20cm

20 से.मी.

**Candidate Answer:** [ NOT ANSWERED ]

Question 69.If  $\cos A + \cos^2 A = 1$  then the value of  $\sin^2 A + \sin^4 A$  is :

यदि  $\cos A + \cos^2 A = 1$  हो, तो  $\sin^2 A + \sin^4 A$  का मान बताइए ?

**Options:**

1)  $\frac{1}{2}$

2)  $\frac{1}{4}$

3)  $\frac{1}{3}$

4) 1

**Correct Answer:** 1

**Candidate Answer:** 1

Question 70. A sum of Rs. 3000 amounts to Rs. 6000 in two years at compound interest. The interest for four years is

Rs. 3000 की राशि चक्रवृद्धि ब्याज पर 2 वर्ष के पश्चात Rs. 6000 हो जाती है। चार वर्ष का ब्याज क्या होगा ?

**Options:**

1) Rs.9000

2) Rs.12000

3) Rs.6000

4) Rs.3000

**Correct Answer:** Rs.9000

**Candidate Answer:** Rs.9000

Question 71. The angles of depression of two ships from the top of a light house are  $45^\circ$  and  $30^\circ$  toward east. If the ships are 200m apart, the height of the light house is (take  $\sqrt{3}=1.73$ )

किसी प्रकाश - स्तंभ के शीर्ष से दो पोतों के अवनमन कोण पूर्व की ओर  $45^\circ$  और  $30^\circ$  हैं। यदि पोत परस्पर 200 मीटर की दूरी पर हो तो प्रकाश-स्तंभ की ऊँचाई बताइए ? (यह मानते हुए कि  $\sqrt{3} = 1.73$ )

**Options:**

1) 273m

273 मी.

2) 270m

270 मी.

3) 253m

253 मी.

4) 263m

263 मी.

**Correct Answer:** 273m

273 मी.

**Candidate Answer:** 273m

273 मी.

Question 72. This is a pie chart for the data on A, B, O, AB blood groups of 150 donors. Observe the pie chart and answer the questions

दिए गए पाई चार्ट में 150 दाताओं के ब्लड ग्रुप A, B, O, AB के आँकड़ों को दर्शाया गया है। पाई चार्ट का अध्ययन कीजिए और प्रश्नों के उत्तर दीजिए।

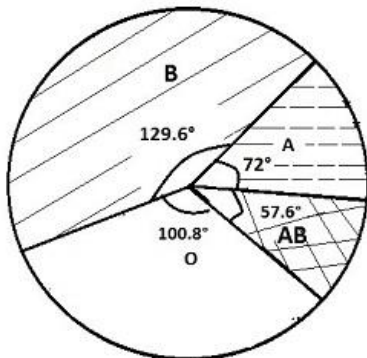

The number of donors having blood group 'O' is:

ऐसे दाताओं की संख्या बताइए जिनका ब्लड ग्रुप 'O' है ?

**Options:**

- 1) 50
- 2) 42
- 3) 30
- 4) 34

**Correct Answer:** 42

**Candidate Answer:** 42

Question 73. This is a pie chart for the data on A, B, O, AB blood groups of 150 donors. Observe the pie chart and answer the questions

दिए गए पाई चार्ट में 150 दाताओं के ब्लड ग्रुप A, B, O, AB के आँकड़ों को दर्शाया गया है। पाई चार्ट का अध्ययन कीजिए और प्रश्नों के उत्तर दीजिए।

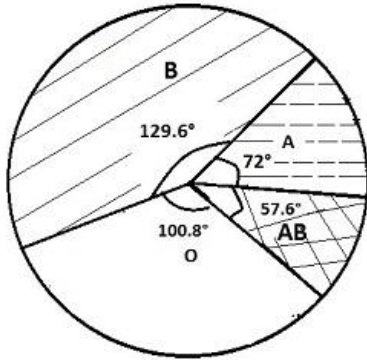

The number of persons having either blood group 'A' or blood group 'B' is

ऐसे व्यक्तियों की संख्या बताइए जिनका ब्लड ग्रुप या तो 'A' हो या 'B' हो?

**Options:**

- 1) 84
- 2) 96
- 3) 78
- 4) 54

**Correct Answer:** 84

**Candidate Answer:** 54

Question 74. This is a pie chart for the data on A, B, O, AB blood groups of 150 donors. Observe the pie chart and answer the questions

दिए गए पाई चार्ट में 150 दाताओं के ब्लड ग्रुप A, B, O, AB के आँकड़ों को दर्शाया गया है। पाई चार्ट का अध्ययन कीजिए और प्रश्नों के उत्तर दीजिए।

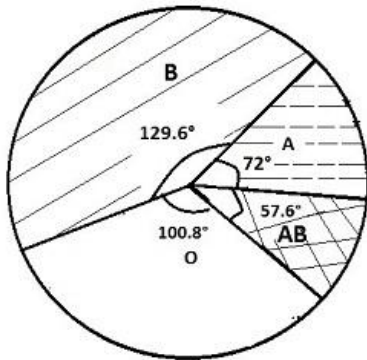

What is the percentage of donor having blood group 'AB' ?

ऐसे दाताओं की प्रतिशतता बताइए जिनका ब्लड ग्रुप 'AB' है ?

**Options:**

- 1) 61%
- 2) 26%
- 3) 16%
- 4) 36%

**Correct Answer:** 16%

**Candidate Answer:** 16%

Question 75. This is a pie chart for the data on A, B, O, AB blood groups of 150 donors. Observe the pie chart and answer the questions

दिए गए पाई चार्ट में 150 दाताओं के ब्लड ग्रुप A, B, O, AB के अंकों को दर्शाया गया है। पाई चार्ट का अध्ययन कीजिए और प्रश्नों के उत्तर दीजिए।

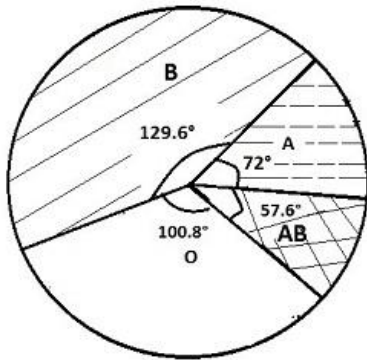

The ratio of donors having blood group 'A' to the average of the donors having blood group 'O', 'B' and 'AB' is

जिन दाताओं का ब्लड ग्रुप 'A' है उनका और जिन दाताओं का ब्लड ग्रुप 'O', 'B' और 'AB' हैं उनके औसत का, अनुपात ज्ञात कीजिए ?

**Options:**

- 1) 4:3
- 2) 4:5
- 3) 5:4
- 4) 3:4

**Correct Answer:** 3:4

**Candidate Answer:** 3:4

Question 76. In the following question, out of the four alternatives, choose the word which best expresses the meaning of the given word and click the button corresponding to it.

ARDUOUS

**Options:**

- 1) FERVENT
- 2) STRONG
- 3) ENTHUSIASTIC
- 4) STRENUOUS

**Correct Answer:** STRENUOUS

**Candidate Answer:** STRONG

Question 77. In the following question, out of the four alternatives, choose the word which is opposite in meaning to the given word and click the button corresponding to it.

QUIESCENT

**Options:**

- 1) IGNORANT
- 2) DORMANT
- 3) INNOCENT
- 4) IMPROPER

**Correct Answer:** DORMANT

**Candidate Answer:** IGNORANT

Question 78. Four words are given, out of which only one word is spelt correctly. Choose the correctly spelt word and click the button corresponding to it.

**Options:**

- 1) Commemorate
- 2) Commemorate
- 3) Comemorate
- 4) Comemorare

**Correct Answer:** Commemorate

**Candidate Answer:** Commemorate

Question 79. In the following questions, one part of the sentence may have an error. Find out which part of the sentence has an error and click the button corresponding to it. If the sentence is free from error, click the "No error" option.

Beside, writing is my hobby, (A) / I had ideas for a couple of short stories (B) / that needed further thought. (C) / No Error (D)

**Options:**

- 1) A
- 2) B
- 3) C
- 4) D

**Correct Answer:** A

**Candidate Answer:** A

Question 80. In the following questions, one part of the sentence may have an error. Find out which part of the sentence has an error and click the button corresponding to it. If the sentence is free from error, click the "No error" option.

He recommended (A) / my case (B) / with the supervisor (C) / No Error (D)

**Options:**

- 1) A
- 2) B
- 3) C
- 4) D

**Correct Answer:** C

**Candidate Answer:** C

Question 81. In the following questions, one part of the sentence may have an error. Find out which part of the sentence has an error and click the button corresponding to it. If the sentence is free from error, click the "No error" option.

Her knowledge in English (A) / gives her great advantage (B) / over me. (C) / No Error (D)

**Options:**

- 1) A
- 2) B
- 3) C
- 4) D

**Correct Answer:** A

**Candidate Answer:** A

Question 82. The sentences given with blanks are to be filled with an appropriate word(s). Four alternatives are suggested for each question. For each question, choose the correct alternative and click the button corresponding to it.

Do not \_\_\_\_\_ your own personal views upon the reader.

**Options:**

- 1) expose
- 2) interpose
- 3) express
- 4) impose

**Correct Answer:** impose

**Candidate Answer:** impose

Question 83. The sentences given with blanks are to be filled with an appropriate word(s). Four alternatives are suggested for each question. For each question, choose the correct alternative and click the button corresponding to it.

This school isn't \_\_\_\_\_ from the last one.

**Options:**

- 1) more different
- 2) any different
- 3) difference
- 4) any difference

**Correct Answer:** any different

**Candidate Answer:** any different

Question 84. The sentences given with blanks are to be filled with an appropriate word(s). Four alternatives are suggested for each question. For each question, choose the correct alternative and click the button corresponding to it.

I have decided \_\_\_\_\_ my course of action.

**Options:**

- 1) upon
- 2) with
- 3) for
- 4) of

**Correct Answer:** upon



**Candidate Answer:** of

Question 85. In each of the questions, four alternatives are given for the Idiom/Phrase. Choose the alternative which best expresses the meaning of the Idiom/Phrase and click the button corresponding to it.

To bury the hatchet

**Options:**

- 1) To make peace
- 2) To dig the ground
- 3) To negotiate
- 4) To make war

**Correct Answer:** To make peace

**Candidate Answer:** [ NOT ANSWERED ]

Question 86. In each of the questions, four alternatives are given for the Idiom/Phrase. Choose the alternative which best expresses the meaning of the Idiom/Phrase and click the button corresponding to it.

Selling like hot cakes

**Options:**

- 1) To have a good season
- 2) To become as planned
- 3) To have a very slow sale
- 4) To have a very good sale

**Correct Answer:** To have a very good sale

**Candidate Answer:** To have a good season

Question 87. In each of the questions, four alternatives are given for the Idiom/Phrase. Choose the alternative which best expresses the meaning of the Idiom/Phrase and click the button corresponding to it.

Scot free

**Options:**

- 1) Unlimited
- 2) Unpunished
- 3) To freedom
- 4) Unrepentant

**Correct Answer:** Unpunished

**Candidate Answer:** [ NOT ANSWERED ]

Question 88. Out of the four alternatives, choose the one which can be substituted for the given words/sentences and click the button corresponding to it.

A thing no longer in use

**Options:**

- 1) Illusion
- 2) Illegal
- 3) Obsolete
- 4) Historic

**Correct Answer:** Obsolete

**Candidate Answer:** Obsolete

Question 89. Out of the four alternatives, choose the one which can be substituted for the given words/sentences and click the button corresponding to it.

A place where astronomical observations are made

**Options:**

- 1) Laboratory
- 2) Observatory
- 3) Astrolibrary
- 4) Astrophery

**Correct Answer:** Observatory

**Candidate Answer:** Observatory

Question 90. Out of the four alternatives, choose the one which can be substituted for the given words/sentences and click the button corresponding to it.

Killing one's sister

**Options:**

- 1) Regicide
- 2) Fratricide
- 3) Matricide
- 4) Sororicide

**Correct Answer:** Sororicide

**Candidate Answer:** [ NOT ANSWERED ]

Question 91. In each of the questions, four alternatives are given for the Idiom/Phrase. Choose the alternative which best expresses the meaning of the Idiom/Phrase and click the button corresponding to it.

Government officials keep throwing the buck to others.

**Options:**

- 1) giving
- 2) passing
- 3) donating
- 4) No improvement

**Correct Answer:** passing

**Candidate Answer:** passing

Question 92. In each of the questions, four alternatives are given for the Idiom/Phrase. Choose the alternative which best expresses the meaning of the Idiom/Phrase and click the button corresponding to it.

She angrily broke up the letter.

**Options:**

- 1) tore up
- 2) break in
- 3) teared up
- 4) No improvement

**Correct Answer:** tore up

**Candidate Answer:** tore up

Question 93. In each of the questions, four alternatives are given for the Idiom/Phrase. Choose the alternative which best expresses the meaning of the Idiom/Phrase and click the button corresponding to it.

They told me that they had build a new house.

**Options:**

- 1) have built
- 2) have build
- 3) had built
- 4) No improvement

**Correct Answer:** had built

**Candidate Answer:** had built

Question 94. In each of the questions, four alternatives are given for the Idiom/Phrase. Choose the alternative which best expresses the meaning of the Idiom/Phrase and click the button corresponding to it.

One should exercise their right to vote

**Options:**

- 1) his
- 2) our
- 3) one's
- 4) No improvement

**Correct Answer:** No improvement

**Candidate Answer:** his

Question 95. In each of the questions, four alternatives are given for the Idiom/Phrase. Choose the alternative which best expresses the meaning of the Idiom/Phrase and click the button corresponding to it.

She sank back with a mourn of pain

**Options:**

- 1) morn
- 2) mourne
- 3) moan
- 4) No improvement

**Correct Answer:** moan

**Candidate Answer:** No improvement

Question 96. A passage is given with 5 questions following it. Read the passage carefully and choose the best answer to each question out of the four alternatives and click the button corresponding to it.

Acharya Jagadish Chandra Bose, one of the greatest of modern scientists, graduated from St. Xavier's College, Kolkata. He then obtained Tripos of Cambridge University and joined the Presidency College, Kolkata, as Professor of Physics. He was a pioneer in the discovery of the wireless and radio and the Microwave. He made remarkable contribution to the science of Botany by proving with the help of an instrument of his own invention that not only do trees and plants have life, but feel pleasure and pain as we do. He was perhaps the first scientist to suggest the possibility of gathering and utilising energy from solar rays. Last but not least was the Bose Institute which he founded in 1917. It has now become a world-famous Research Laboratory doing yeoman's service to various branches of science.

Acharya Jagadish Chandra Bose, one of the greatest of modern scientists, graduated from which college?

**Options:**

- 1) St. Xavier's College, Kolkata
- 2) Cambridge University
- 3) Presidency College, Kolkata
- 4) Bose Institute

**Correct Answer:** St. Xavier's College, Kolkata

**Candidate Answer:** St. Xavier's College, Kolkata

Question 97. A passage is given with 5 questions following it. Read the passage carefully and choose the best answer to each question out of the four alternatives and click the button corresponding to it.

Acharya Jagadish Chandra Bose, one of the greatest of modern scientists, graduated from St. Xavier's College, Kolkata. He then obtained Tripos of Cambridge University and joined the Presidency College, Kolkata, as Professor of Physics. He was a pioneer in the discovery of the wireless and radio and the Microwave. He made remarkable contribution to the science of Botany by proving with the help of an instrument of his own invention that not only do trees and plants have life, but feel pleasure and pain as we do. He was perhaps the first scientist to suggest the possibility of gathering and utilising energy from solar rays. Last but not least was the Bose Institute which he founded in 1917. It has now become a world-famous Research Laboratory doing yeoman's service to various branches of science.

What is meant by yeoman service?

**Options:**

- 1) Minimal
- 2) Invaluable
- 3) Discreet
- 4) Sporadic

**Correct Answer:** Invaluable

**Candidate Answer:** Invaluable

Question 98. A passage is given with 5 questions following it. Read the passage carefully and choose the best answer to each question out of the four alternatives and click the button corresponding to it.

Acharya Jagadish Chandra Bose, one of the greatest of modern scientists, graduated from St. Xavier's College, Kolkata. He then obtained Tripos of Cambridge University and joined the Presidency College, Kolkata, as Professor of Physics. He was a pioneer in the discovery of the wireless and radio and the Microwave. He made remarkable contribution to the science of Botany by proving with the help of an instrument of his own invention that not only do trees and plants have life, but feel pleasure and pain as we do. He was perhaps the first scientist to suggest the possibility of gathering and utilising energy from solar rays. Last but not least was the Bose Institute which he founded in 1917. It has now become a world-famous Research Laboratory doing yeoman's service to various branches of science.

Acharya Jagadish Chandra Bose was a pioneer in the discovery of the wireless, radio and the \_\_\_\_\_ .

**Options:**

- 1) Toaster
- 2) Oven
- 3) Microwave
- 4) Radio

**Correct Answer:** Microwave

**Candidate Answer:** Microwave

Question 99. A passage is given with 5 questions following it. Read the passage carefully and choose the best answer to each question out of the four alternatives and click the button corresponding to it.

Acharya Jagadish Chandra Bose, one of the greatest of modern scientists, graduated from St. Xavier's College, Kolkata. He then obtained Tripos of Cambridge University and joined the Presidency College, Kolkata, as Professor of Physics. He was a pioneer in the discovery of the wireless and radio and the Microwave. He made remarkable contribution to the science of Botany by proving with the help of an instrument of his own invention that not only do trees and plants have life, but feel pleasure and pain as we do. He was perhaps the first scientist to suggest the possibility of gathering and utilising energy from solar rays. Last but not least was the Bose Institute which he founded in 1917. It has now become a world-famous Research Laboratory doing yeoman's service to various branches of science.

Jagadish Chandra Bose made remarkable contribution to the science of Botany by proving with the help of an instrument of his own invention that trees and plants have not only life, but \_\_\_\_\_ .

**Options:**

- 1) feel joyous and excited as we do.
- 2) feel happy and sad as we do.
- 3) feel excitement and pain as we do.
- 4) feel pleasure and pain as we do.

**Correct Answer:** feel pleasure and pain as we do.

**Candidate Answer:** feel pleasure and pain as we do.

Question 100. A passage is given with 5 questions following it. Read the passage carefully and choose the best answer to each question out of the four alternatives and click the button corresponding to it.

Acharya Jagadish Chandra Bose, one of the greatest of modern scientists, graduated from St. Xavier's College, Kolkata. He then obtained Tripos of Cambridge University and joined the Presidency College, Kolkata, as Professor of Physics. He was a pioneer in the discovery of the wireless and radio and the Microwave. He made remarkable contribution to the science of Botany by proving with the help of an instrument of his own invention that not only do trees and plants have life, but feel pleasure and pain as we do. He was perhaps the first scientist to suggest the possibility of gathering and utilising energy from solar rays. Last but not least was the Bose Institute which he founded in 1917. It has now become a world-famous Research Laboratory doing yeoman's service to various branches of science.

What is meant by a Tripos from Cambridge University?

**Options:**

- 1) A scholarship
- 2) A trophy
- 3) A degree
- 4) A medallion

**Correct Answer:** A degree

**Candidate Answer:** [ NOT ANSWERED ]